

Manual Frame (FR-CONF)

Codes:		
Article number	FR-PSR-CONF, FR PSRP-CONF, FR-ISMS-CONF	
Product name	Manual Frame incl. mounting system for (VAL) PSR, PSR TC, PSR PLUS, ISMS	
General:		
Dimensions: L x W x H (mm) (Gross)	850 mm (L) X 794 mm (W) X 331 mm (H)	Incl. Packaging
Dimensions: L x W x H (mm) (Net)	806 mm (L) X 760 mm (W) X 1624 mm (H) (after assembly)	Excl. packaging
Gross weight (Kg)	~ 34	Incl. packaging
Net weight (Kg)	30	Excl. packaging
Colour	Stainless Steel (Grinded)	
Technical specifications:		
Total weight of frame (kg)	30	Without accessories
Maximum weight to be mounted on the Upper Part of the frame (kg)	85	e.g. Powersealer
Maximum weight to place on Accessories (kg)	25	BSP, RC
Height adjustment (floor till center mountingplate) (mm)	min 963 - max 1376	Floor to middle mountingplate
Fixation	4 wheels (2 with brake) / or 4 Feet	
Standards:		
Machine Directive	2006/42/EC	
RoHS Directive	2011/65/EU	
Standards (ISO/IEC/EN/NEN)	EN ISO 12100: 2010	
Accessories:		
Included Parts:	Manual, Assembly Manual, 2x Wrench, Fasteners	
Accessories:	Bag support table with mounting assembly	
	Roller conveyer with mounting assembly	
	Height adjustment feet	

Manual Frame (FR-CONF)

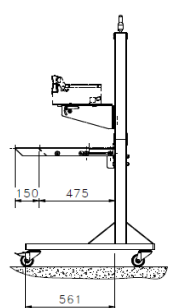
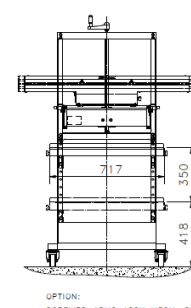
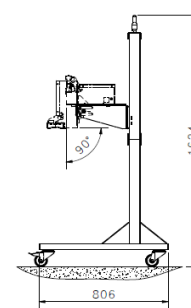
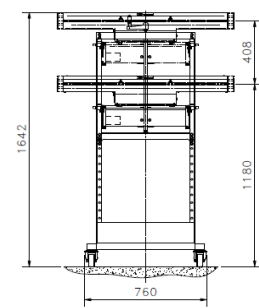
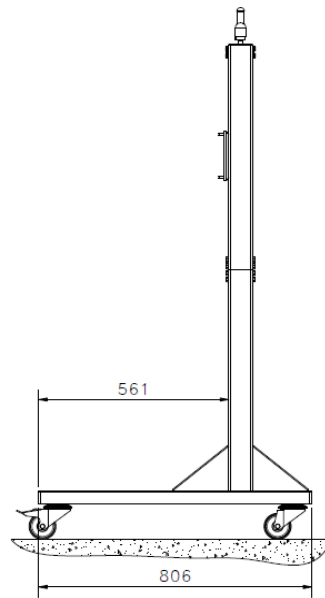
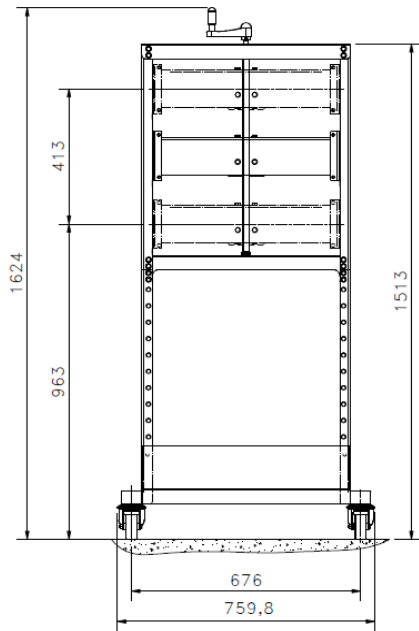

OPTION:
SCREWED ARMS ASSY MECH. SUPPORT
+ BAG SUPPORT TABLE ASSY

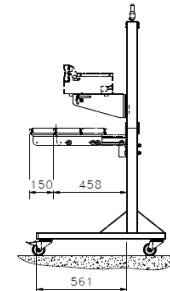
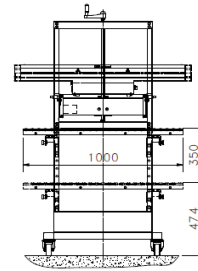

OPTION:
SCREWED ARMS ASSY MECH. SUPPORT
+ ROLLER CONVEYOR ASSY